

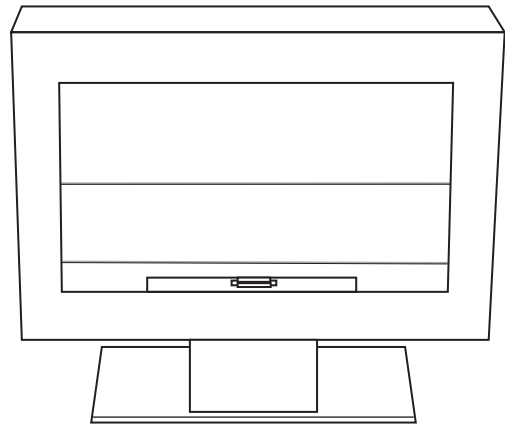

**anywhere
FIREPLACE™**







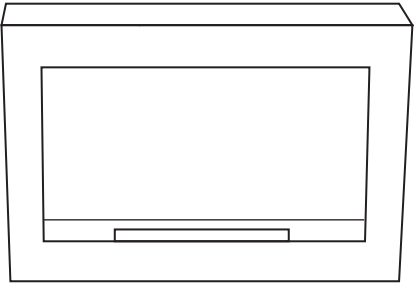
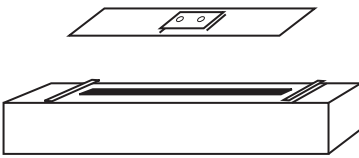
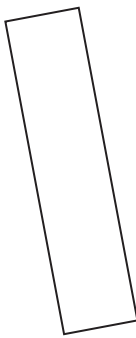

www.anywherefireplace.com
Devco LLC
Larchmont, NY 10538

This product has been designed for your enjoyment. Please carefully read all warnings and installation instructions before use.

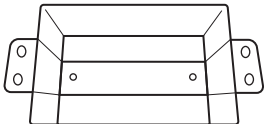
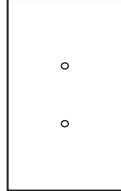

Model: Tribeca II Model # 90201

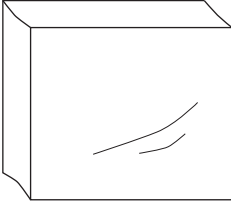
INCLUDED ITEMS

 <p>FIREPLACE FRAME (A) x 1</p>	 <p>BURNER (TWO PIECES) (B) x 1</p>	 <p>GLASS PANEL (C) x 1</p>	 <p>.5" SCREW (K) x 4</p>	
			 <p>PLASTIC WASHER (L) x 2</p>	
			 <p>.75" SCREW (M) x 2</p>	
 <p>STAND (H) x 1</p>	 <p>BLACK GLASS BASE (I) x 1</p>	 <p>HANDLE (J) x 1</p>	 <p>FIREPLACE COVER (D) x 1</p>	 <p>HEX TOOL (G) x 1</p>
			 <p>FUNNEL (N) x 1</p>	

ANYWHERE FIREPLACE™ TRIBECA II MODEL

The elegant design of the **Tribeca II** model **Anywhere Fireplace™** on a stand will create a dramatic statement and architectural interest to any room. Just place it on the floor in any room and your guest will be impressed at the high style and sophistication it adds to your décor. It is ventless, requiring no chimney or gas line because it uses clean burning bio-ethanol liquid fuel that is smokeless, odorless, and leaves no soot or ash. You can place the **Anywhere Fireplace™** in your house, condo, apartment, office or restaurant. Its beautiful black satin finish is sure to match most any décor and adds a rich warm atmosphere to your bedroom, living room, den, dining room... This unique, impressive, eco-friendly answer to today's fireplace creates a bright yellow, orange and red flame, spreading cheerful glow across the room. The liquid bio-ethanol fuel is non-toxic, non-polluting, has no messy clean up and is virtually free of maintenance. One liter of fuel can burn for up to 5 hours. It is specially designed for indoor or outdoor use with special powder coating finish to give you that flexibility. For outdoor use, we also include a cover to ensure that no water or debris gets into the burner or in through the back.

QUESTIONS

For any questions related to parts or installation visit us on the web at **www.anywherefireplace.com**, email us at **info@anywherefireplace.com** or call 914-834-5855.

WARNING

The **Anywhere Fireplace™** is **ONLY** to be used with **BIO-ETHANOL LIQUID FUEL FOR FIREPLACES**. The bio-ethanol fuel is a flammable product that requires strict adherence of the safety instructions.

IMPORTANT SAFETY MEASURES

- This fireplace will produce heat, but should not be used as a main source of heat
- Be sure to keep any flammable materials such as drapes/curtains and any decorations at least 4 ft away from fireplace
- Do not place any items on top of or inside fireplace
- Do not touch the fireplace while lit or still hot
- **USE ONLY APPROVED BIO-ETHANOL LIQUID FUEL FOR FIREPLACES**
- It is extremely dangerous and forbidden to use bio-ethanol car fuel or any other unapproved fuel
- Always use a funnel to fill the fireplace with fuel
- Never fill the burner more than $\frac{3}{4}$ full
- **Never add fuel to the burner while fire is burning or unit is still hot. Allow at least 15 minutes for fuel tray to cool down before refueling**
- Do not ingest bio-ethanol fuel and avoid contact with eyes and skin
- Be sure to not spill any fuel outside of the burner. If you do spill, make sure to wipe up all spillage before igniting the fire
- Only use a long match or long lighter to ignite fire
- Be sure to have a fire extinguishing device in the proximity of the fireplace in case of emergencies
- Never leave a lit fireplace unattended
- Be sure to keep children and pets away from the fireplace while lit and while still hot after extinguishing
- Do not smoke when filling the burner with fuel
- Store your fuel containers away from any heat source
- Be sure to store and keep your fuel away and out of reach of children and pets
- To adjust flame height, use handle to open/close burner lid
- To extinguish flame, use burner handle to close burner completely
- It is forbidden to modify this fireplace in any way
- Make sure you place the outdoor cover over the fireplace is you will be using it outdoor to ensure that no water or debris get into the burner or in through the back.

FUEL INFORMATION

- **USE ONLY APPROVED BIO-ETHANOL LIQUID FUEL FOR FIREPLACES**
- **Bio-Ethanol Liquid Fuel** for fireplaces burns clean without emitting any toxins into the air. Only harmless water vapor and CO₂ are produced as byproducts
- **Bio-Ethanol Liquid Fuel** may be purchased at www.anywherefireplace.com.

ASSEMBLY INSTRUCTIONS

Step 1



Take fireplace frame (Part A) out of plastic bag and lay the backside onto a carpet or towel with opening facing up.

Step 2

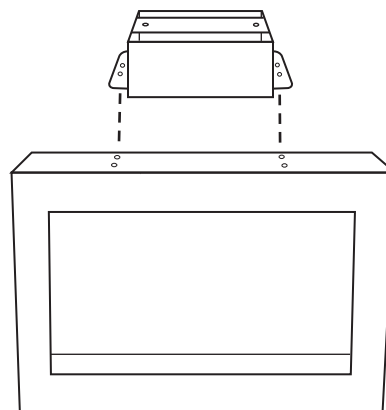

Turn your fireplace upside-down onto its top and place the stand (Part H) onto the fireplace. Make sure the flanges that stick out line up with the 4 holes pre-drilled in the fireplace.

Step 3

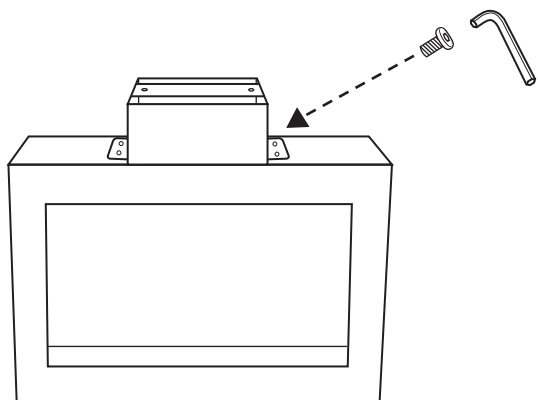

Attach the stand to the fireplace frame using the 4 .5" screws (Part K) using the provided hex tool.

Step 4

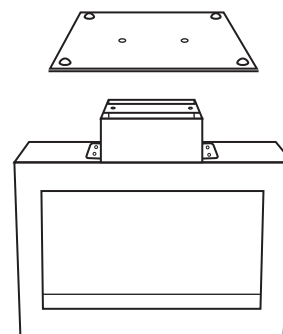

Now place the black glass base (Part I) over the stand so that the holes in the glass line up with the holes on the bottom of the stand. Make sure the rubber feet on the glass base are facing you. This will become the bottom of the fireplace.

Step 5

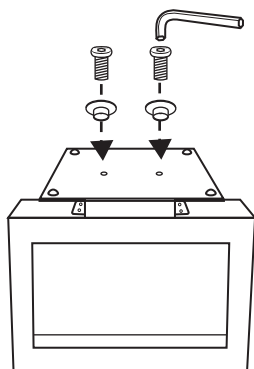

Insert plastic washers (Part L) into the holes on the glass base (Part I) and secure the glass base onto the stand using the thick .75" screws (Part M) using the hex tool provided. Be sure not to over tighten. Until screws are secured, glass may not be stable. Be careful and insure that glass base does not fall before securing.

Step 6

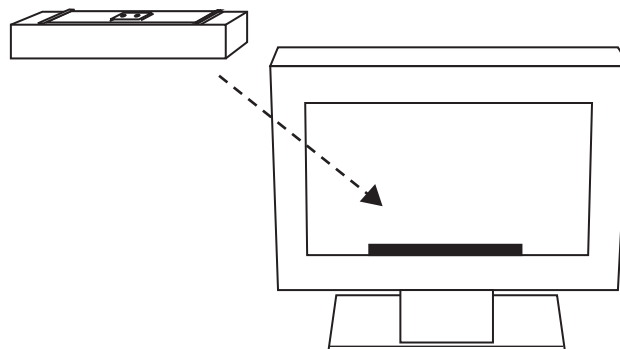

Turn your fireplace over onto the base so that it is now standing right side up and place the burner (Part B) into the recessed hole in your fireplace frame.

Step 7

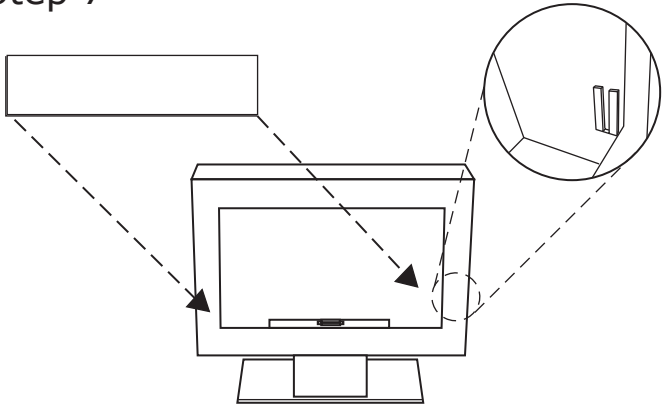

Insert glass panel into the slots located on the inner sides of the fireplace.

Step 8

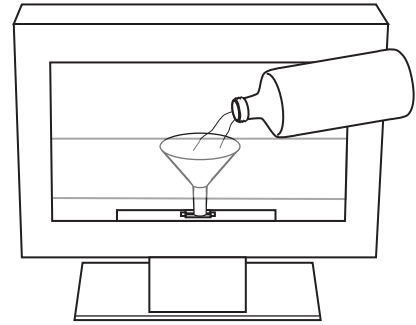

Using the funnel provided, (Part N), carefully pour in the liquid ethanol fuel for fireplaces into the burner about $\frac{3}{4}$ full. Make sure you do not over fill the burner. If any fuel does spill, you should always wipe it up prior to lighting your fireplace.

Step 9

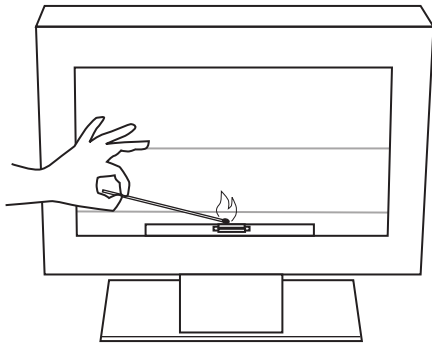

Be sure to use a long lighter or long match to light the fuel in the burner and ENJOY! Never refill while hot. Wait until it is cool to touch.

Step 10

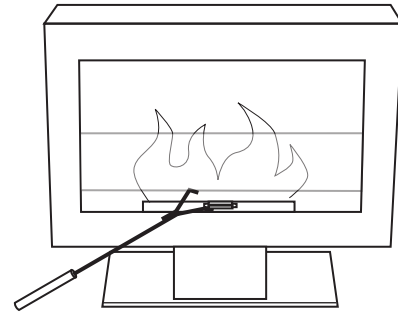

The curved ends in the handle provided (Part J) will fit into the holes in the lid of the burner. You can adjust the flame height to get the desired flame height and heat output. When you are ready to extinguish the fireplace, use the handle to slide the lid of the burner completely closed over the opening to cut off the oxygen supply to the fuel. This will snuff out the flame.

CAUTION: Fireplace will be hot while lit and may stay hot for a while after extinguishing the flame. ALWAYS USE CAUTION when lighting the fireplace. Never fill the burner with more fuel while the fireplace is still hot or burning. Allow it to cool down before refilling with fuel.

Also supplied with your fireplace is a cover that fits over it. If you plan to use your fireplace outside, please keep it covered when not in use to insure that water and debris does not get into the burner and prevent it from functioning properly. **Never put cover on while fireplace is hot.**

NOTE: Should you choose to mount your fireplace on the wall rather than use it on a stand, the base may be removed and with a wall-mount part kit it can be converted to a wall-mount fireplace. The wall-mount part kit is available for sale at www.anywherefireplace.com.